

Electric Circuits

Homework Set 8

1. Using superposition, find V_o in the following circuit.

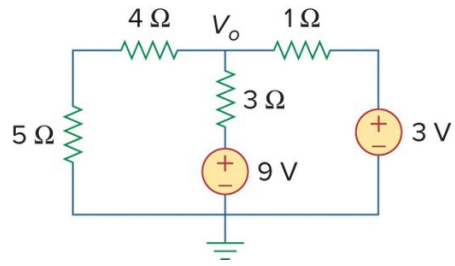

2. Use superposition to find v_o and i_o in the circuit below.

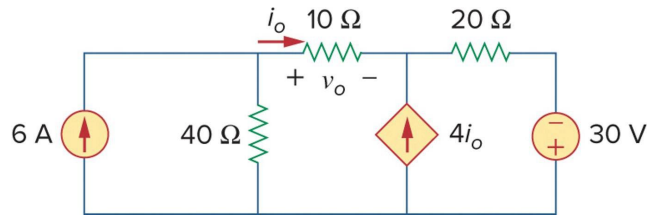

3. Use superposition to find v_o in the circuit below.

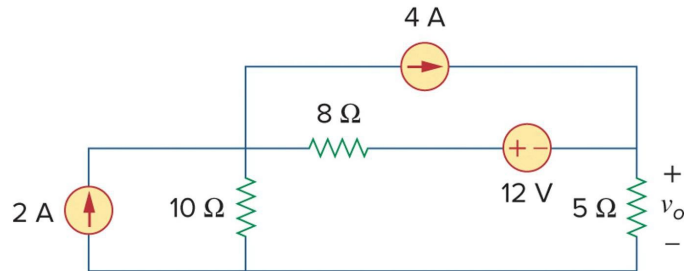

4. Using superposition, find V_o in the following circuit.

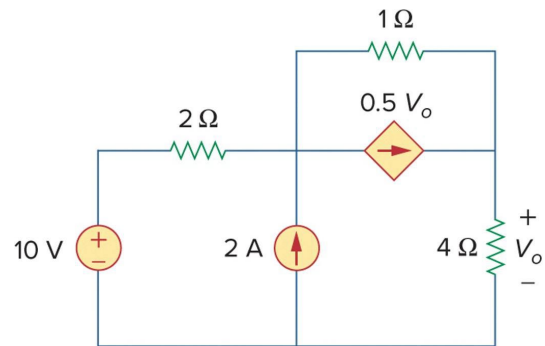

5. Use source transformations to find i in the following circuit.

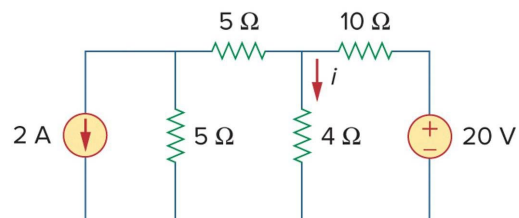

6. Apply source transformations to find v_x in the circuit below.

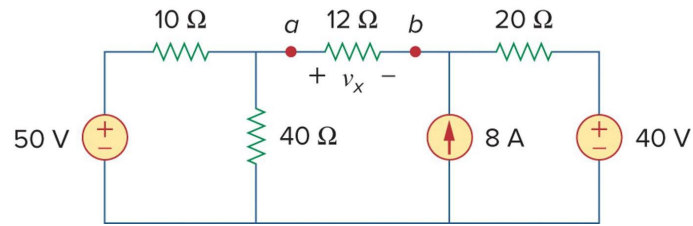

7. Use the source transformation method to find i_o in the following circuit.

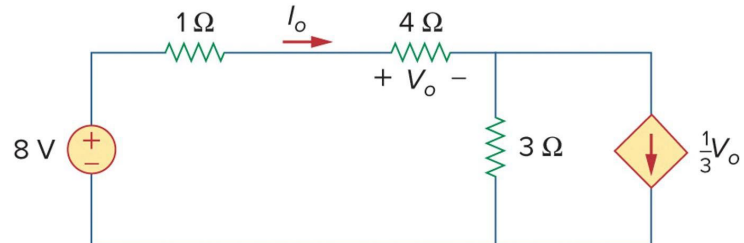

8. Apply the source transformation method to find i_x in the circuit below.

